

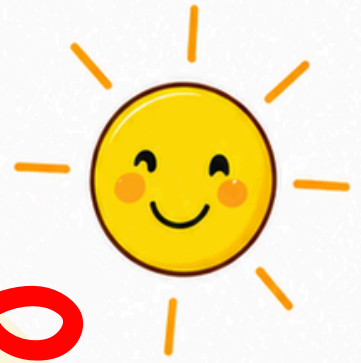

MON CAHIER D'ACTIVITÉS DE L'ÉTÉ

Je m'entraîne en m'amusant !





Bienvenue



Bienvenue dans ton cahier
d'activités de l'été !
Amuse-toi chaque jour
avec des jeux, des
exercices et des coloriages
pour continuer à apprendre
tout en t'amusant !



À tes stylos STABILO !



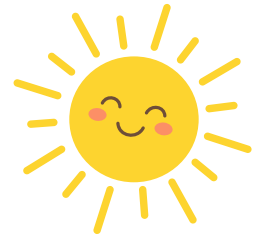

PETITE PRODUCTION ÉCRITE

Raconte tes vacances
en 3 phrases.

A large rectangular area with rounded corners, containing 15 horizontal lines for writing. The lines are evenly spaced and extend across most of the width of the page.

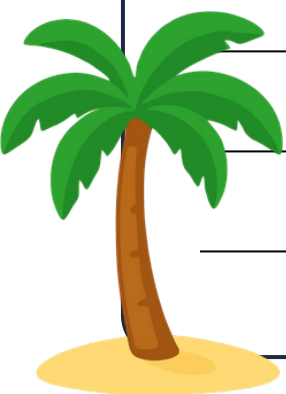

JEU DES DIFFÉRENCES

Trouve les 5 différences entre ces deux dessins.



1 - Couleur du seau 2 - Couleur du ballon 3 - Nuage 4 - Drapeau sur le château 5 - Casquette du petit garçon

LABYRINTHE



Aide l'enfant à retrouver sa trousse pour la rentrée !

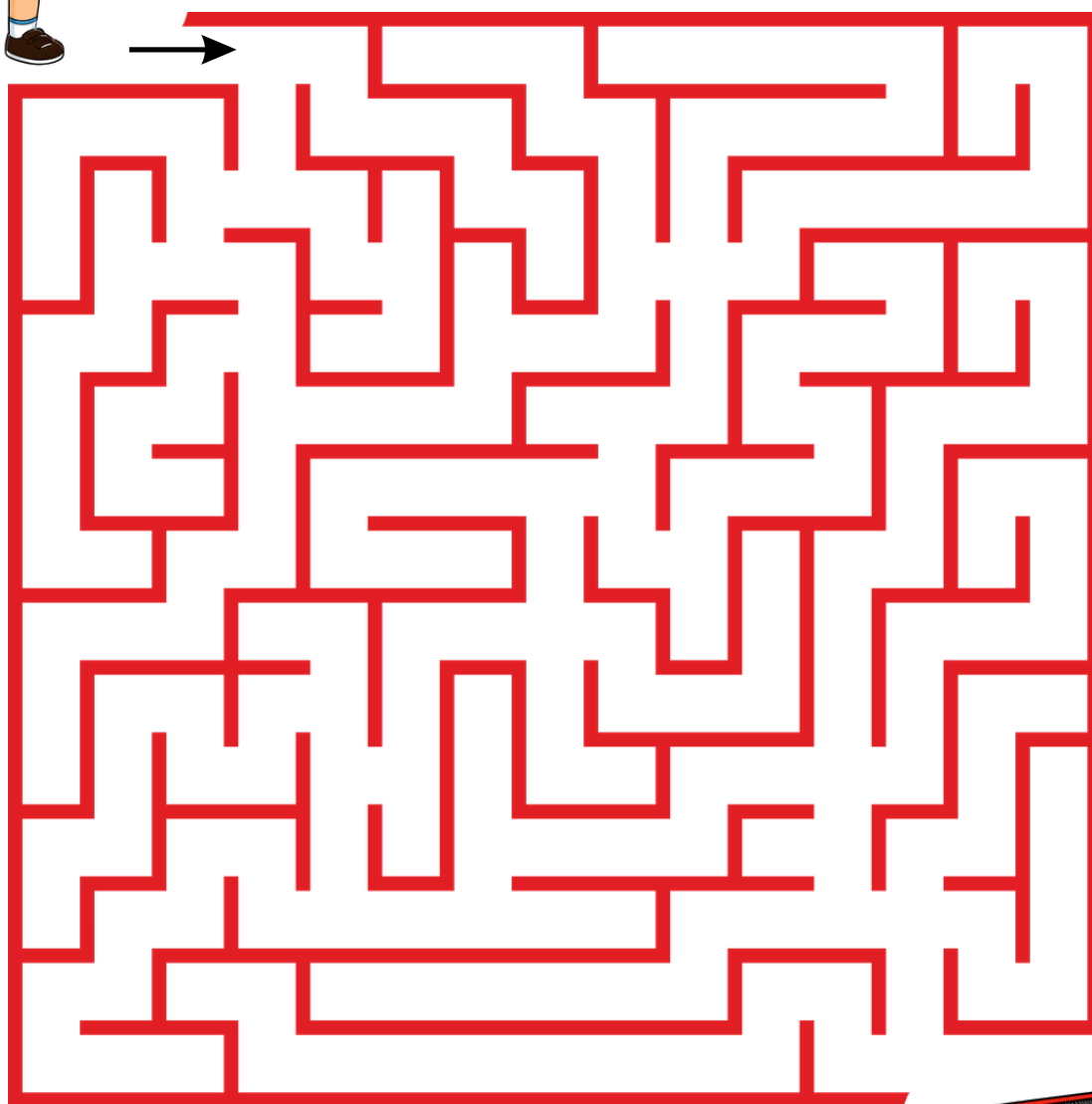

SUDOKU

Complète ce sudoku.

Chaque ligne, chaque colonne et chaque carré contiennent chaque image une seule fois.

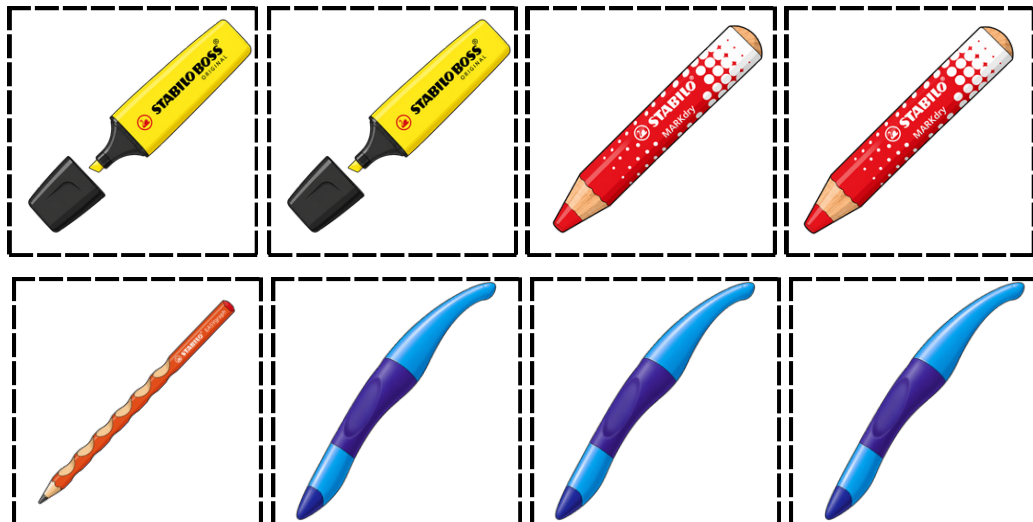
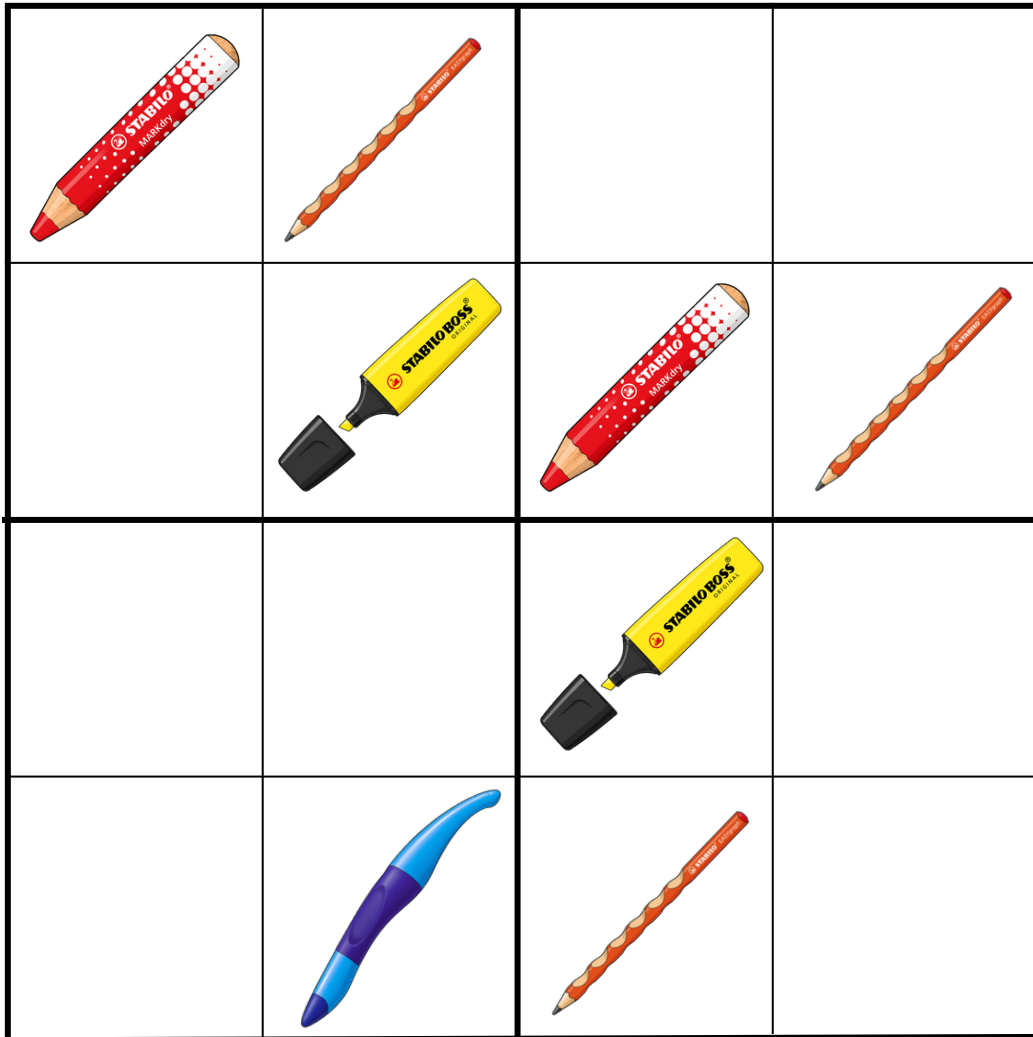

COLORIAGE

Colorie avec tes stylos STABILO préférés !

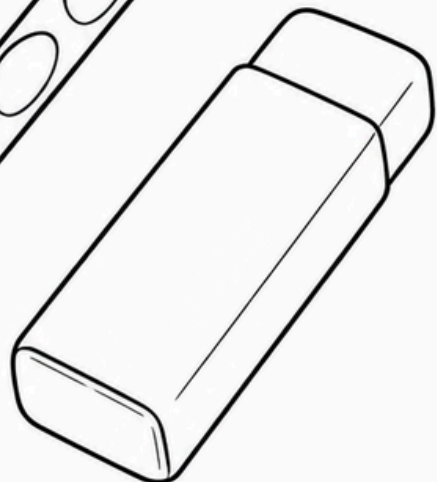
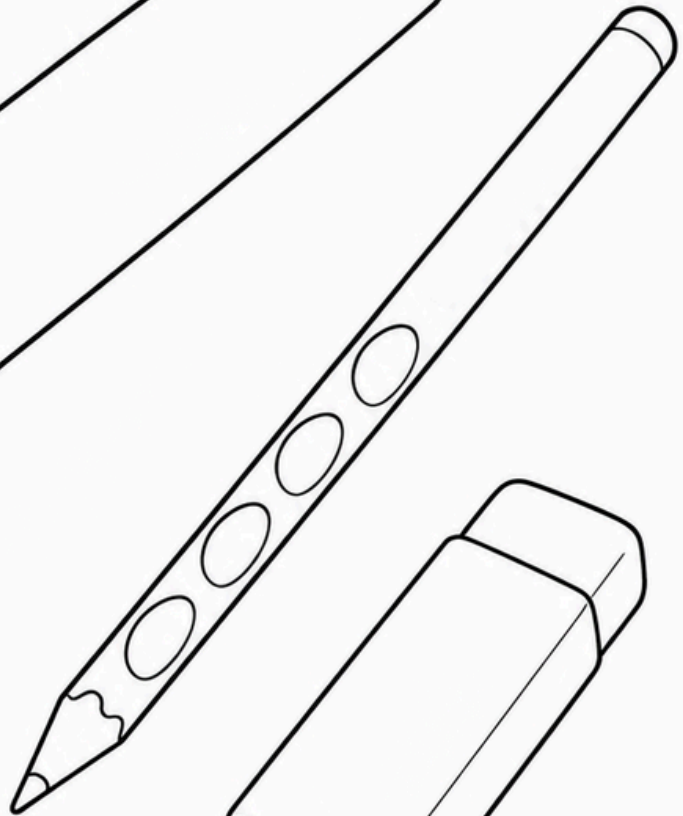
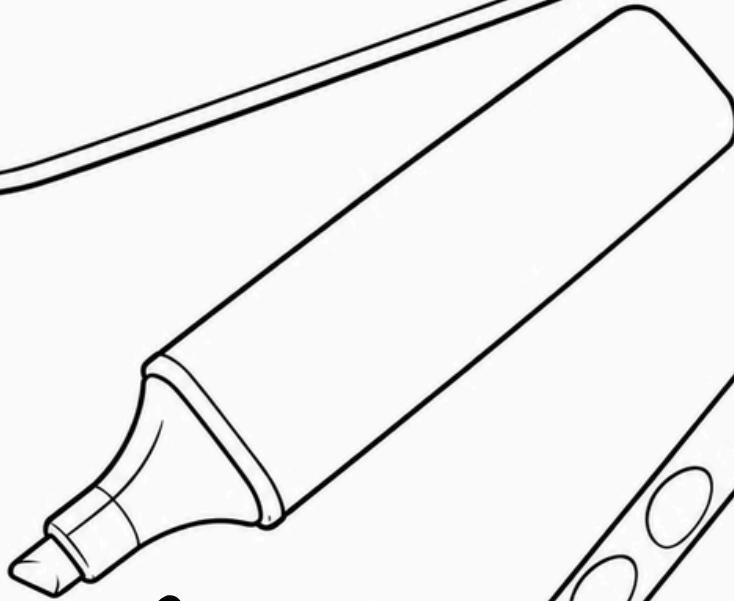
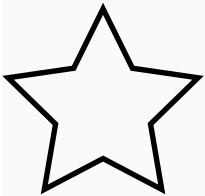
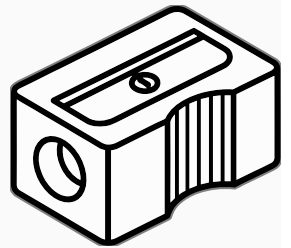
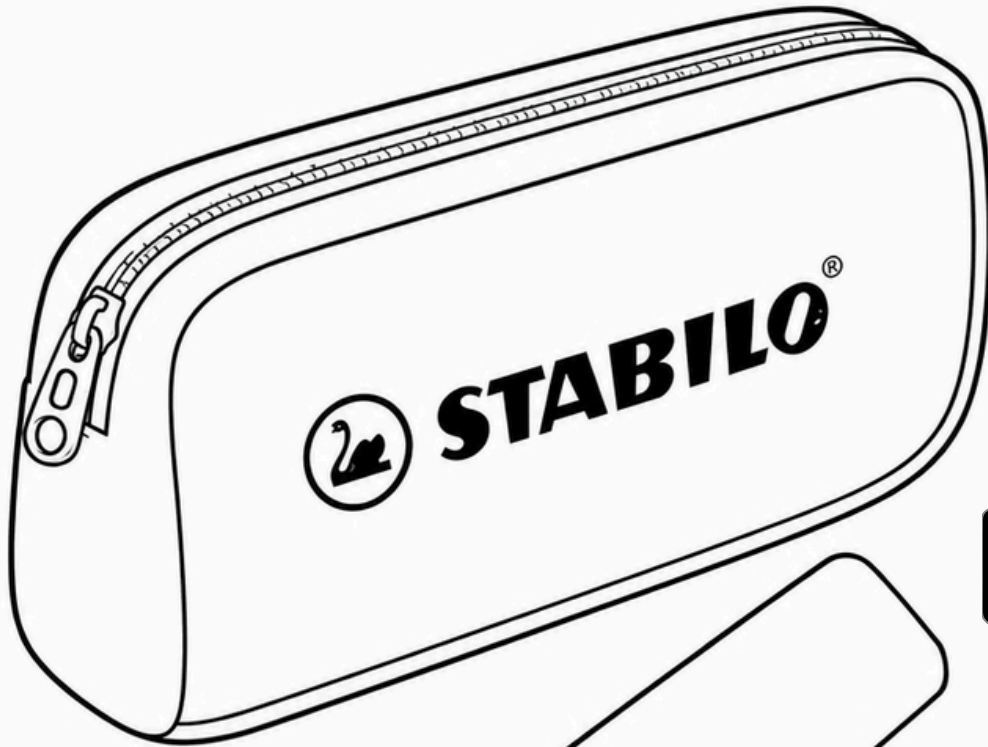
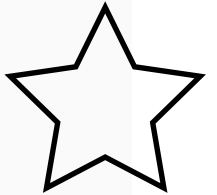

DESSIN LIBRE

Dessine ton cartable idéal.



CALCULS SIMPLES

Calcule et écris le résultat.

$5 + 2 = \underline{\hspace{2cm}}$

$8 - 3 = \underline{\hspace{2cm}}$

$4 + 4 = \underline{\hspace{2cm}}$

$10 - 6 = \underline{\hspace{2cm}}$

$7 + 3 = \underline{\hspace{2cm}}$

$9 - 2 = \underline{\hspace{2cm}}$



MOTS MÊLÉS

Cherche les mots cachés et entoure-les.



- SURLIGNEUR**
- AGENDA**
- CLASSEUR**

- STYLO**
- GOMME**
- CAHIER**

- CARTABLE**
- TROUSSE**
- CRAYON**

CHERCHE ET TROUVE

Observe bien l'image et trouve :

3 stylos

3 crayons

1 gomme

1 surligneur



LES CONSEILS DE STABILO

Bien préparer sa rentrée !



Prépare ton matériel à l'avance

Une trousse bien organisée, c'est un esprit prêt à apprendre !



Personnalise tes cahiers et ton agenda

Des couleurs et des accessoires qui te ressemblent donnent envie de travailler.



Utilise les couleurs pour mieux mémoriser

Surligne les informations importantes et crée un code couleur pour t'organiser facilement.



Garde confiance en toi

Chaque nouvelle année scolaire est une belle occasion d'apprendre, de progresser et de s'amuser.



Félicitations !



Tu as terminé ton cahier d'activités !
Continue à t'amuser
et à apprendre tout
l'été.

À bientôt pour de
nouvelles aventures !

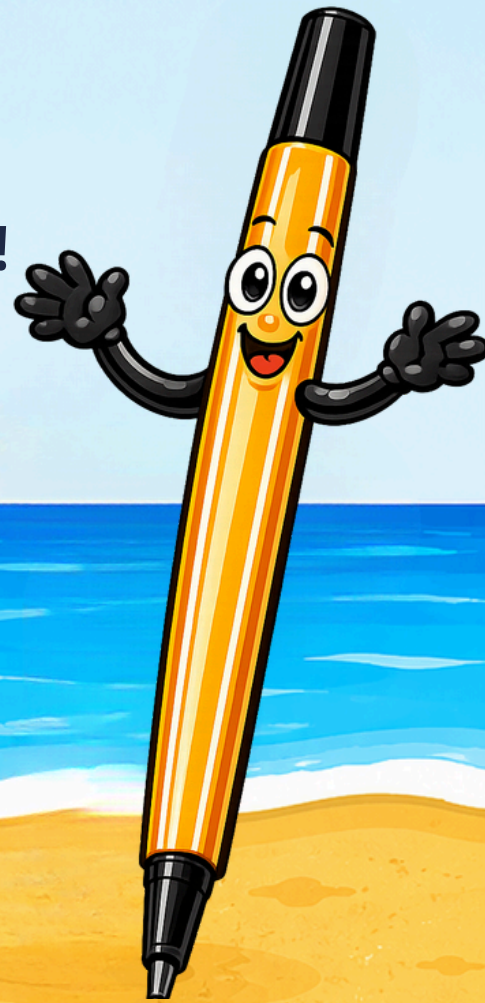

Ce cahier d'activités vous est offert par :



x



x

